

How to set up fMRI studies: Technical Considerations

M A Oghabian
www.oghabian.net

Guidelines for performing an fMRI study

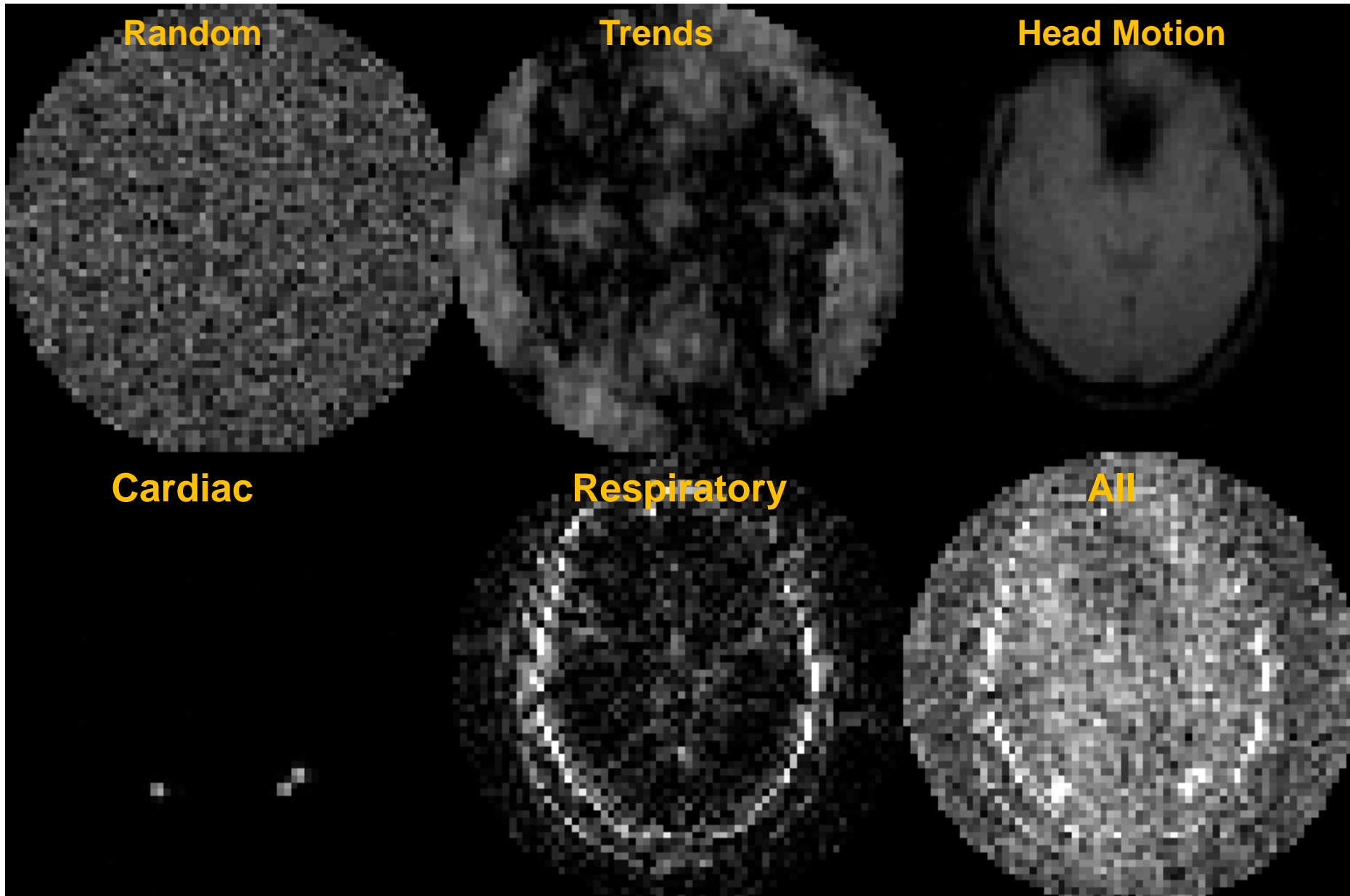
- The goal of any scientific work is to allow other researchers to replicate their study.
- Performing and reporting all methodological details provide understanding and reproducibility of the research work by others.
- Since Neuroimaging is such a multidisciplinary science, methodological issues and documentations should be done by physicists, physiologists, psychologists and statisticians.

Major Sources of Artifact/Variation in fMRI

- Susceptibility artifacts
 - Image distortion
 - Intravoxel dephasing
 - k-space (sequence) dependence
- Physiological noise
 - Cardiac
 - Respiratory
- Motion
- Contrast
 - T2* (BOLD) or T1
- Random noise and trends

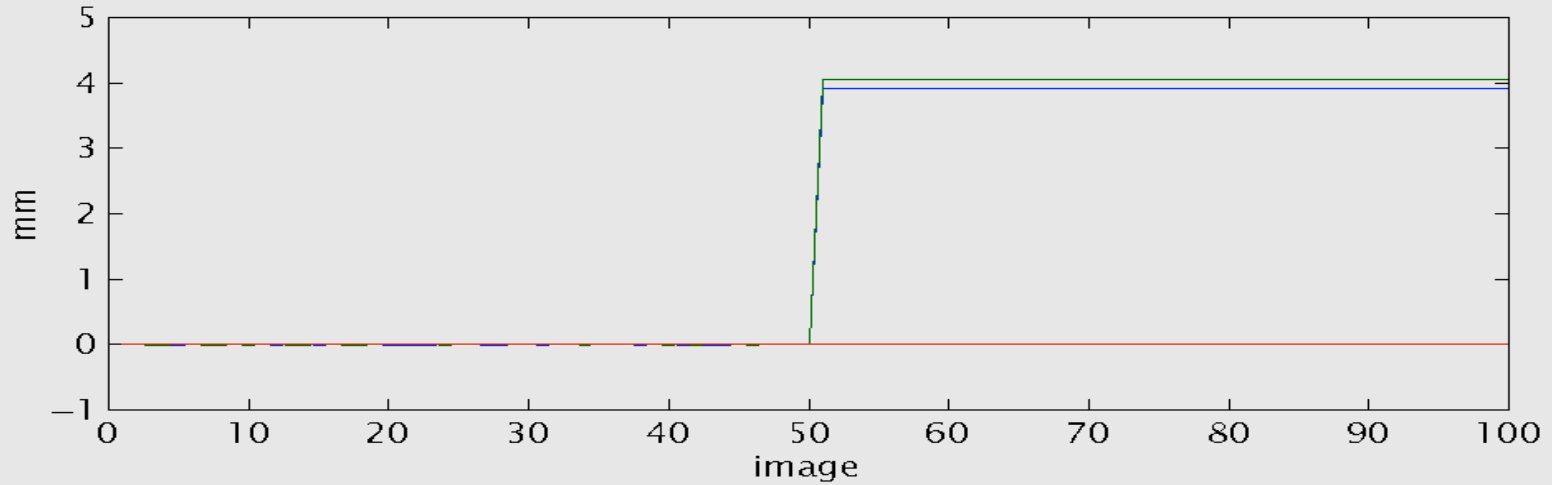
Effects of Noise and Artifacts on fMRI Images

Noise and Trends

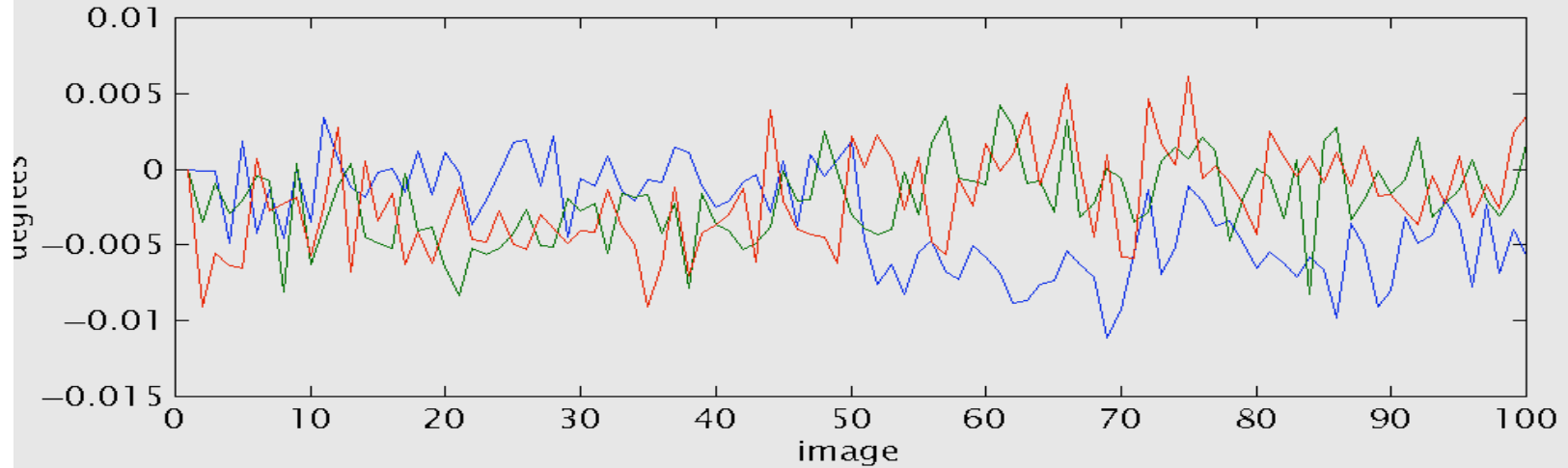


Motion effects

translation

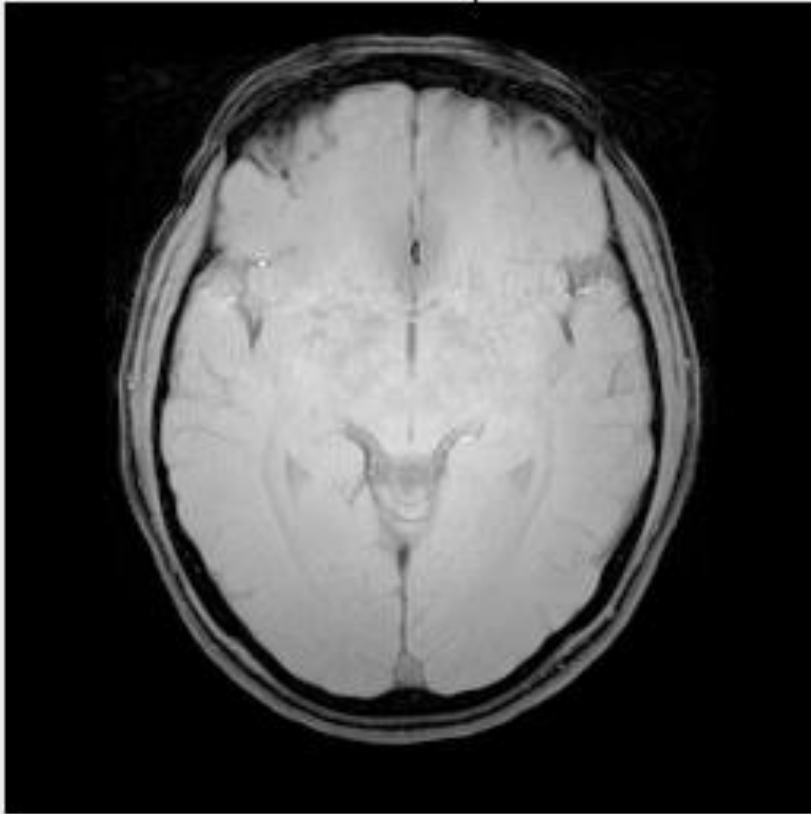


rotation

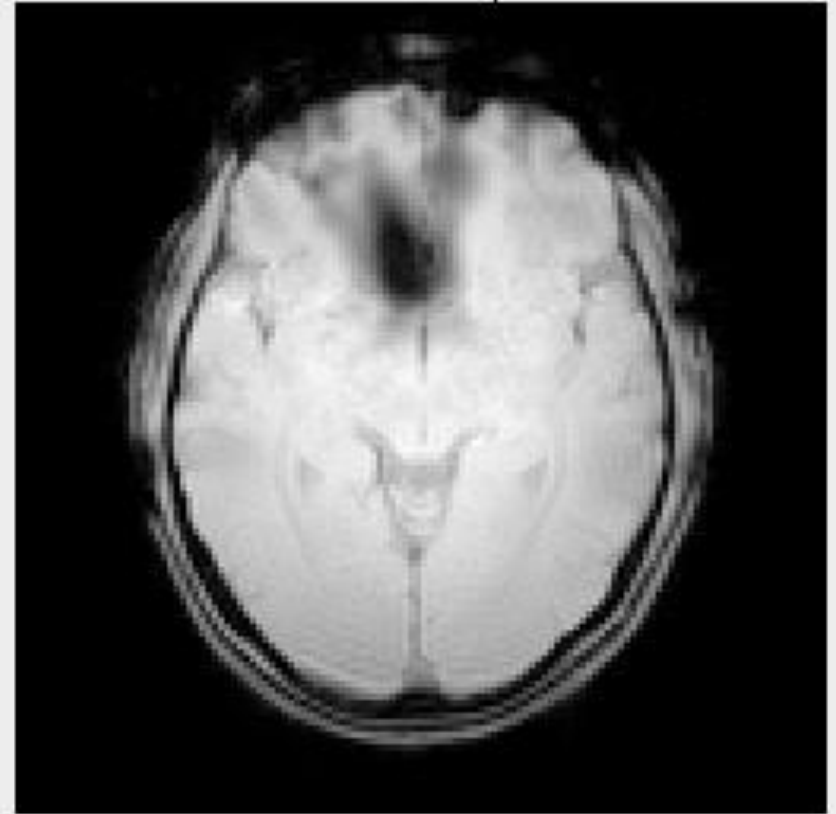


B0 field distortion effect

Structural Acquisition



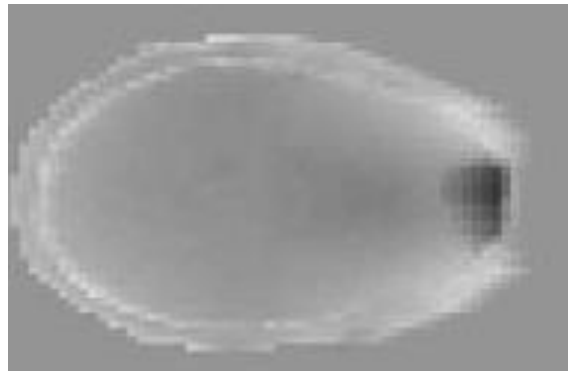
Functional Acquisition



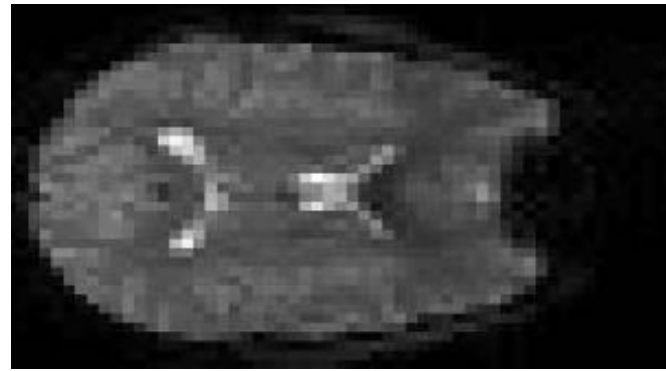
B_0 Inhomogeneity:

Unwarping geometric distortion

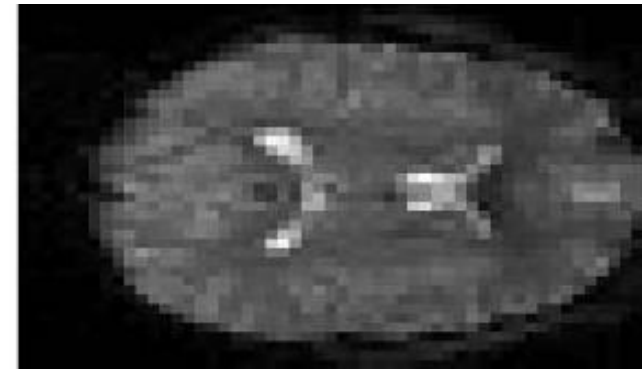
- This geometric distortion is most notable near regions where there is a tissue/air interface (eg sinuses and frontal and temporal lobes).
- To remove: a field map is acquired (combining additional EPI images with different gradient echo weightings).
- This shows the strength of the deviation in magnetic field at each voxel, which is proportional to the amount of distortion along the phase encode direction



Field Map



Before Unwarping

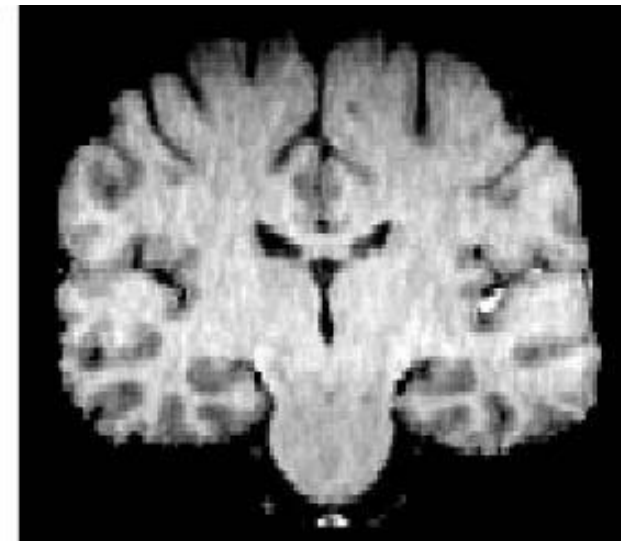
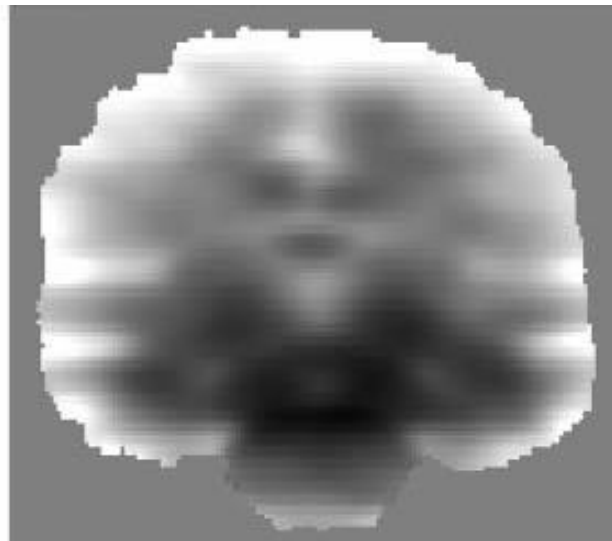
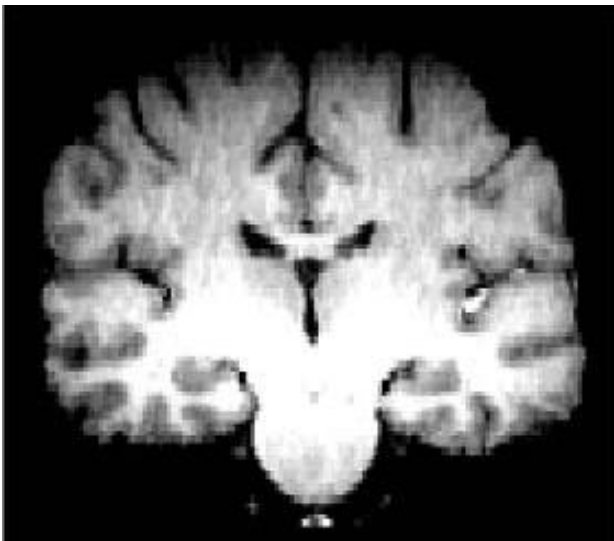


After Unwarping

Dark areas: fields less than external field, bright areas: fields higher than external one

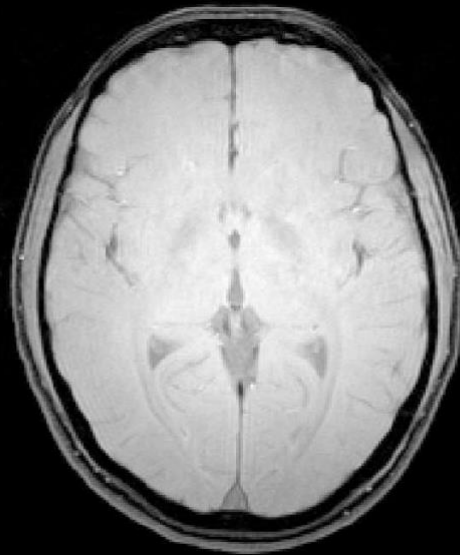
Bias field

- Intensity variations across the image, due to radio frequency (RF) field inhomogeneity

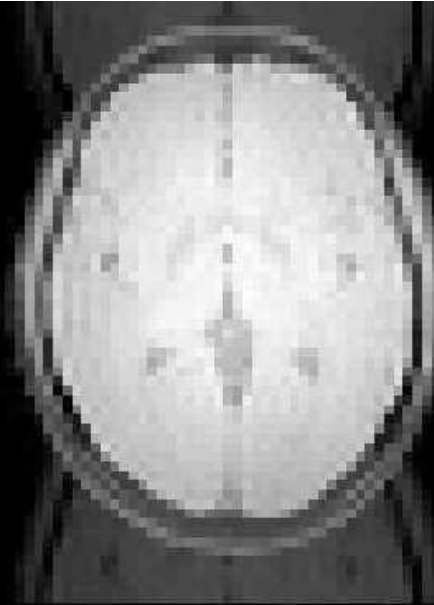


original image estimated bias field restored image

Echo Planar Images



Structural Image



Ghosting

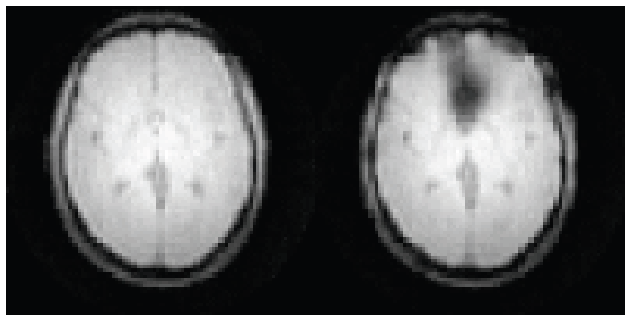


Intravoxel Dephasing

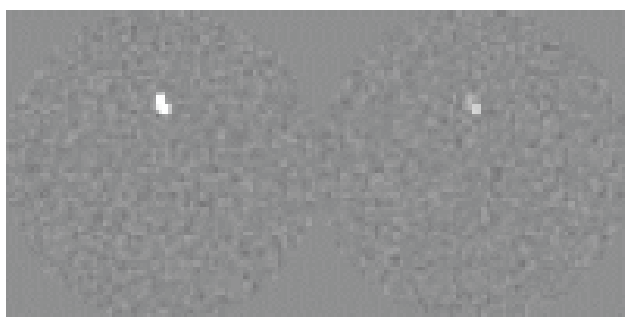
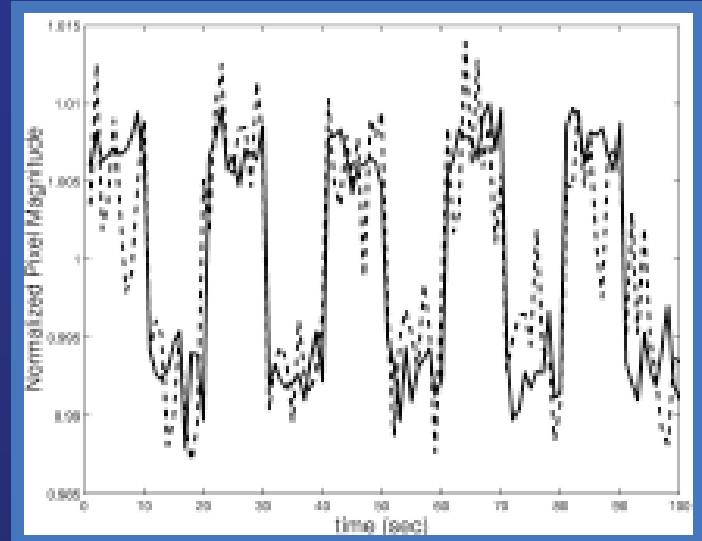


Image Distortion

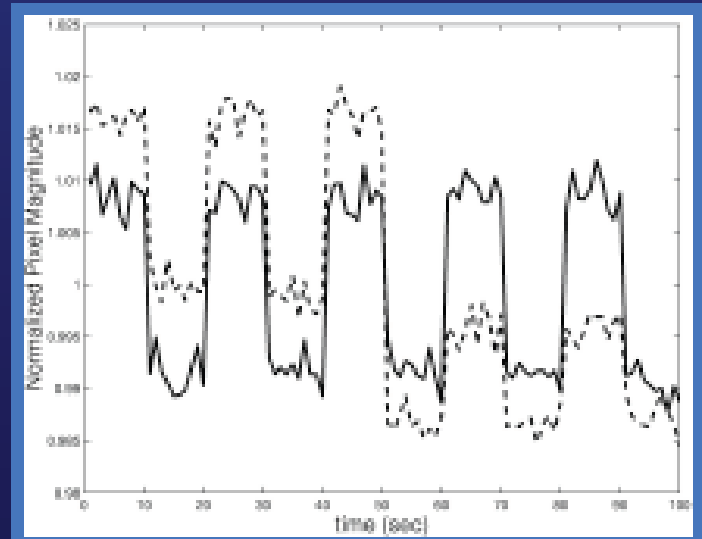
Signal Change by Bold Artifacts



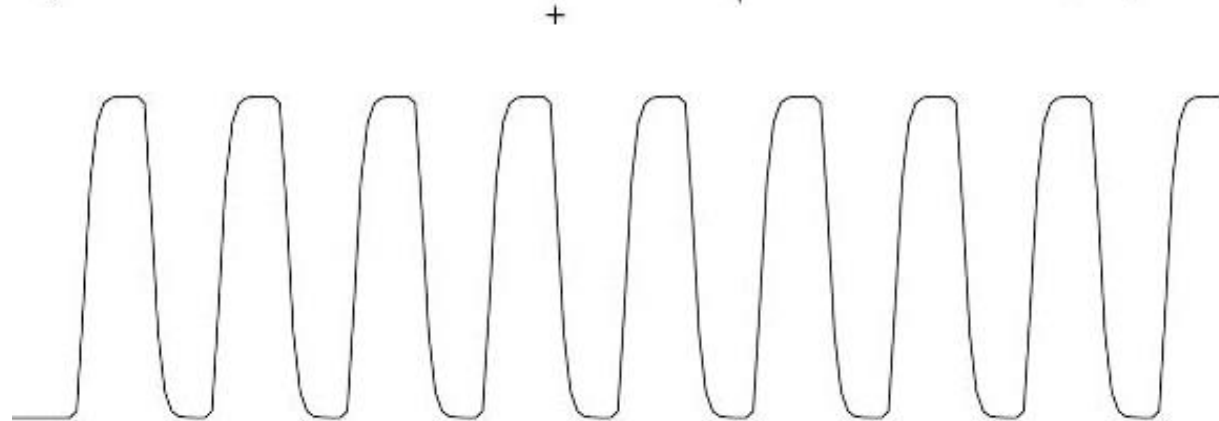
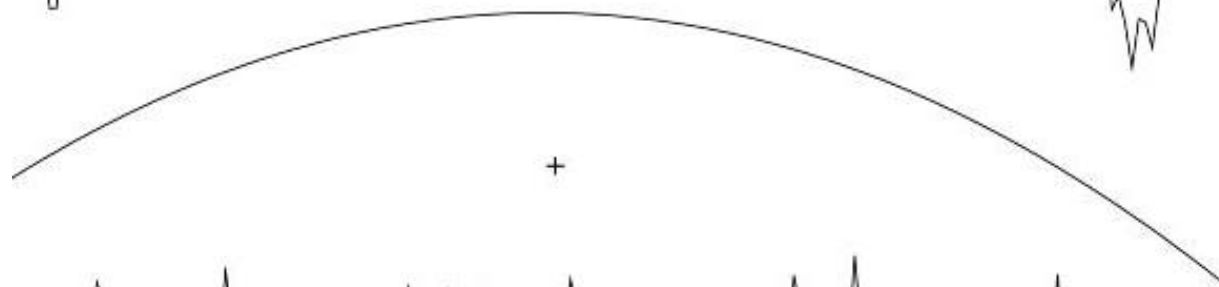
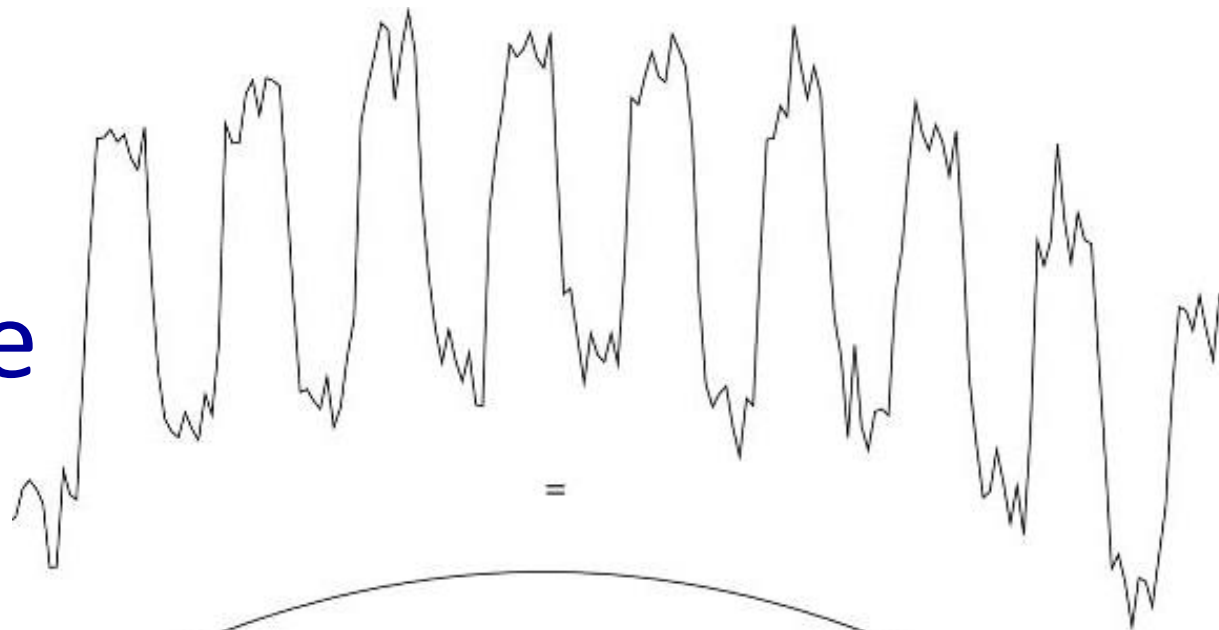
**Susceptibility
Artifact**



**Motion
Artifact**



Signal Change by Noise



Imaging Parameter effects

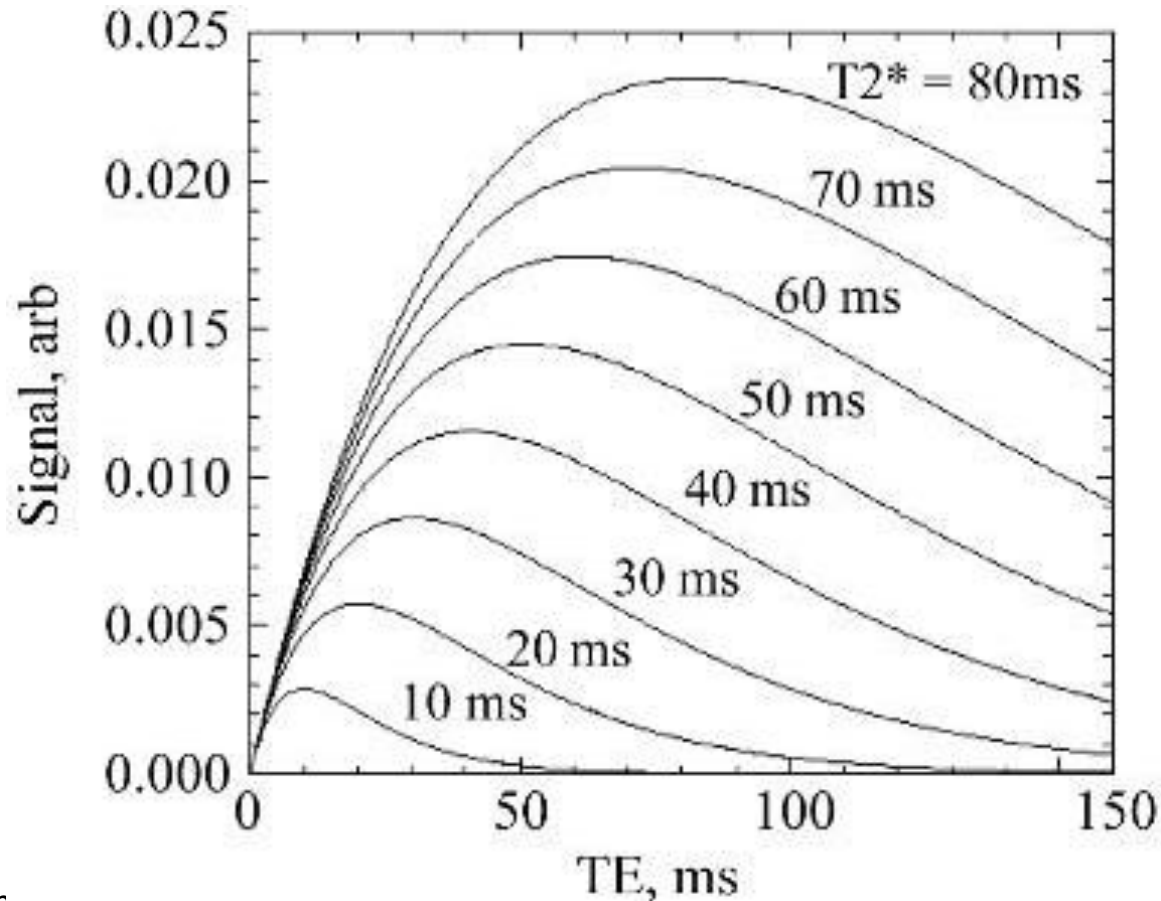
Effect of field homogeneity on optimum TE values and BOLD signal

$$R2^* = R2 + R2_{mi} + R2_{ma}$$

Mi= microscopic field heterogeneity due to the presence of deoxyhaemoglobin

Ma= macroscopic field homogeneity (magr shimming)

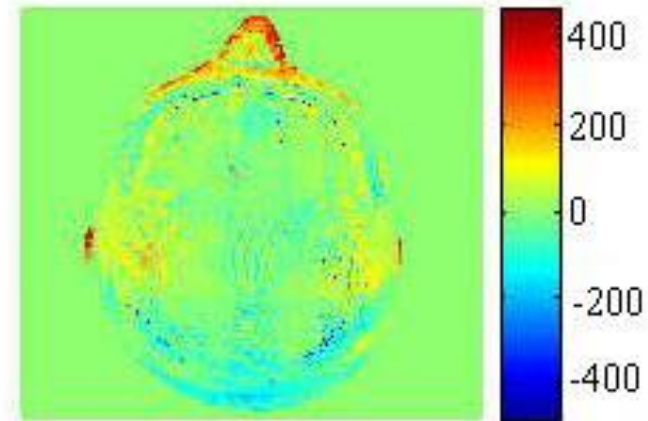
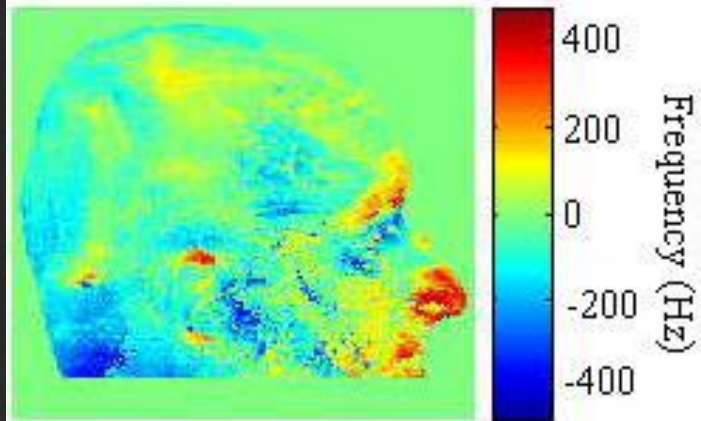
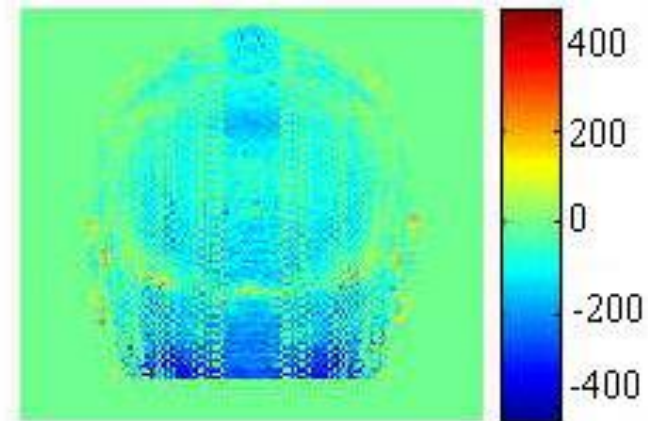
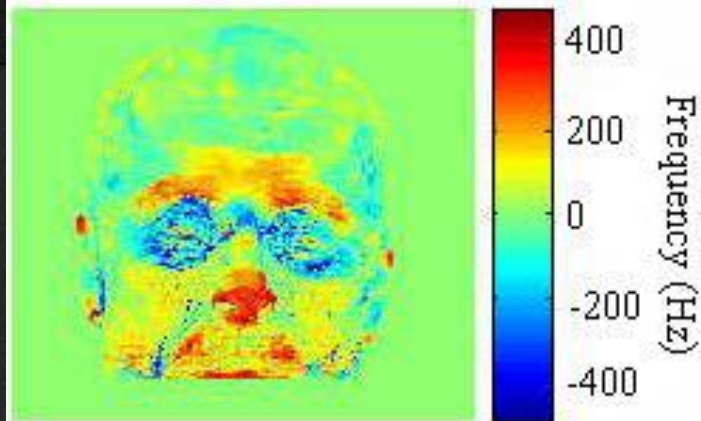
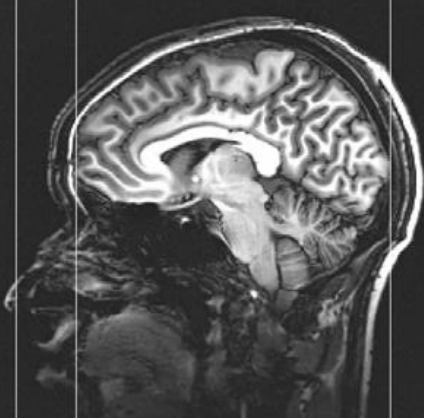
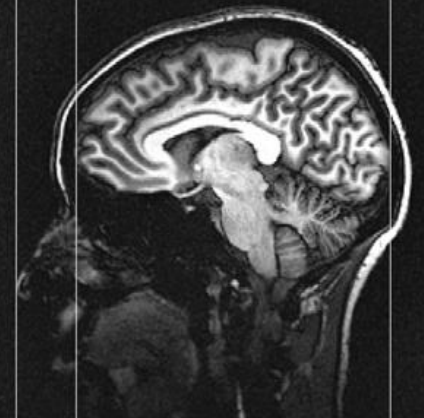
R2= 1/T2 relaxation process.



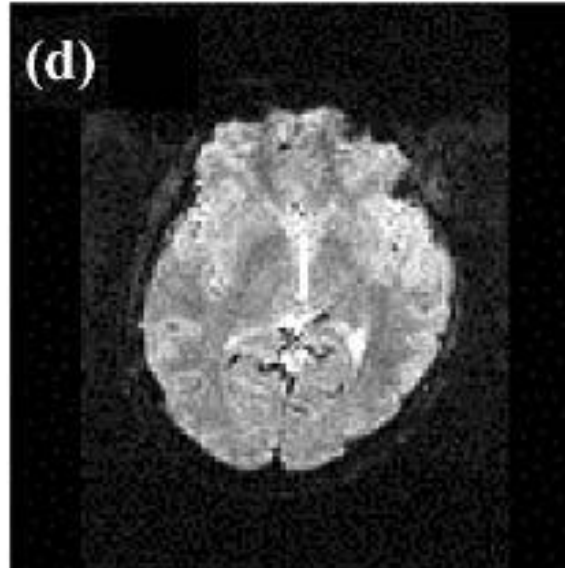
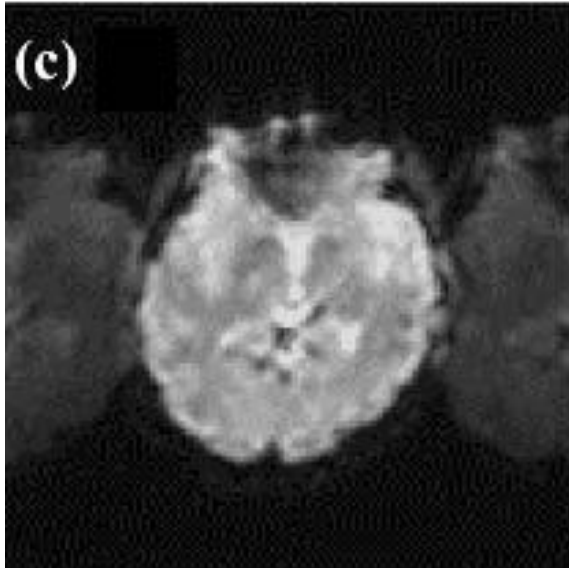
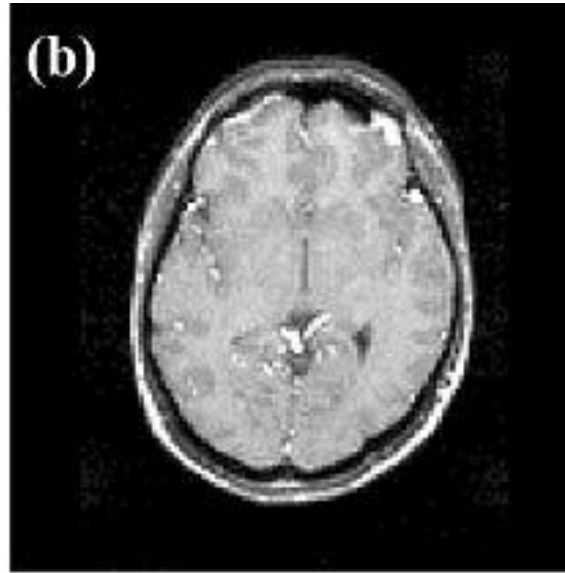
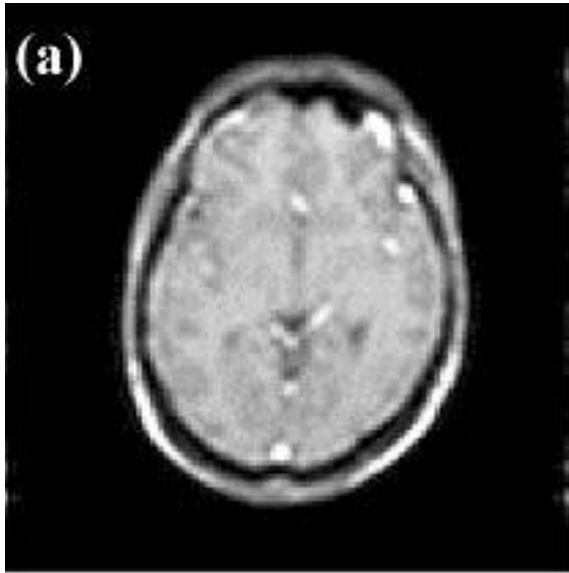
Magnitude of the BOLD effect as a function of TE for different levels of macroscopic magnetic field inhomogeneity

Effect of bandwidths

$\Delta\omega$ weighted image showing skin shift in Hz (Geometric Distortion) for different BW: 217, 108 & 40Hz in regions local to air tissue interfaces using standard sequences



Effect of Resolution

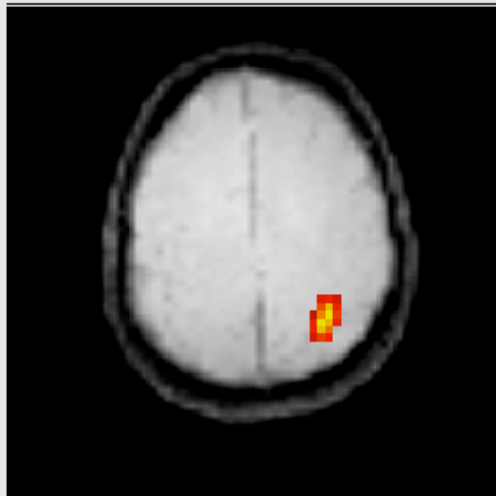


Spin Echo (a & b)
and gradient echo
EPI (c & d) With
resolutions of
4 x 4 x 4 mm
and 2 x 2 x 2 mm

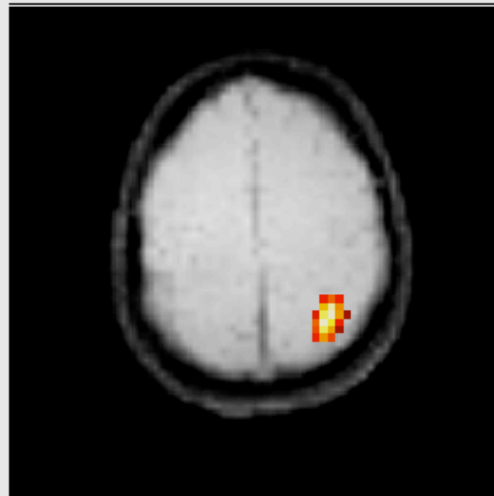
Low resolution
EPI exhibits more
clear signal loss #
in the region of
poor
homogeneity in
prefrontal cortex

Slice Thickness effect

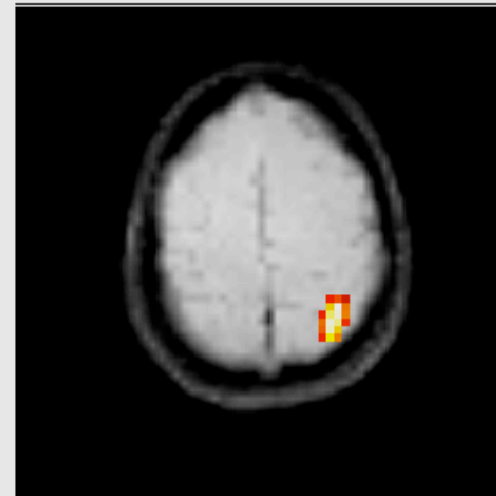
$z = 18\text{mm}$



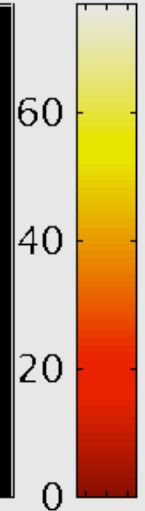
$z = 22\text{mm}$



$z = 28\text{mm}$



T value



Off-resonance effects of fat spins in EPI

- The difference in resonance frequency (i.e. 220 Hz at 1.5 Tesla, 440 Hz at 3 T) of fatty tissues cause displacement in phase direction.
- For EPI, the size of displacement depends on both **readout** sampling bandwidth (ie. 1500–3000 Hz/pixel), and **BW** in **phase** encode direction (ie. 20–30 Hz/pixel).
- Therefore, chemical shift displacements is negligible in readout direction, but substantial In phase direction.

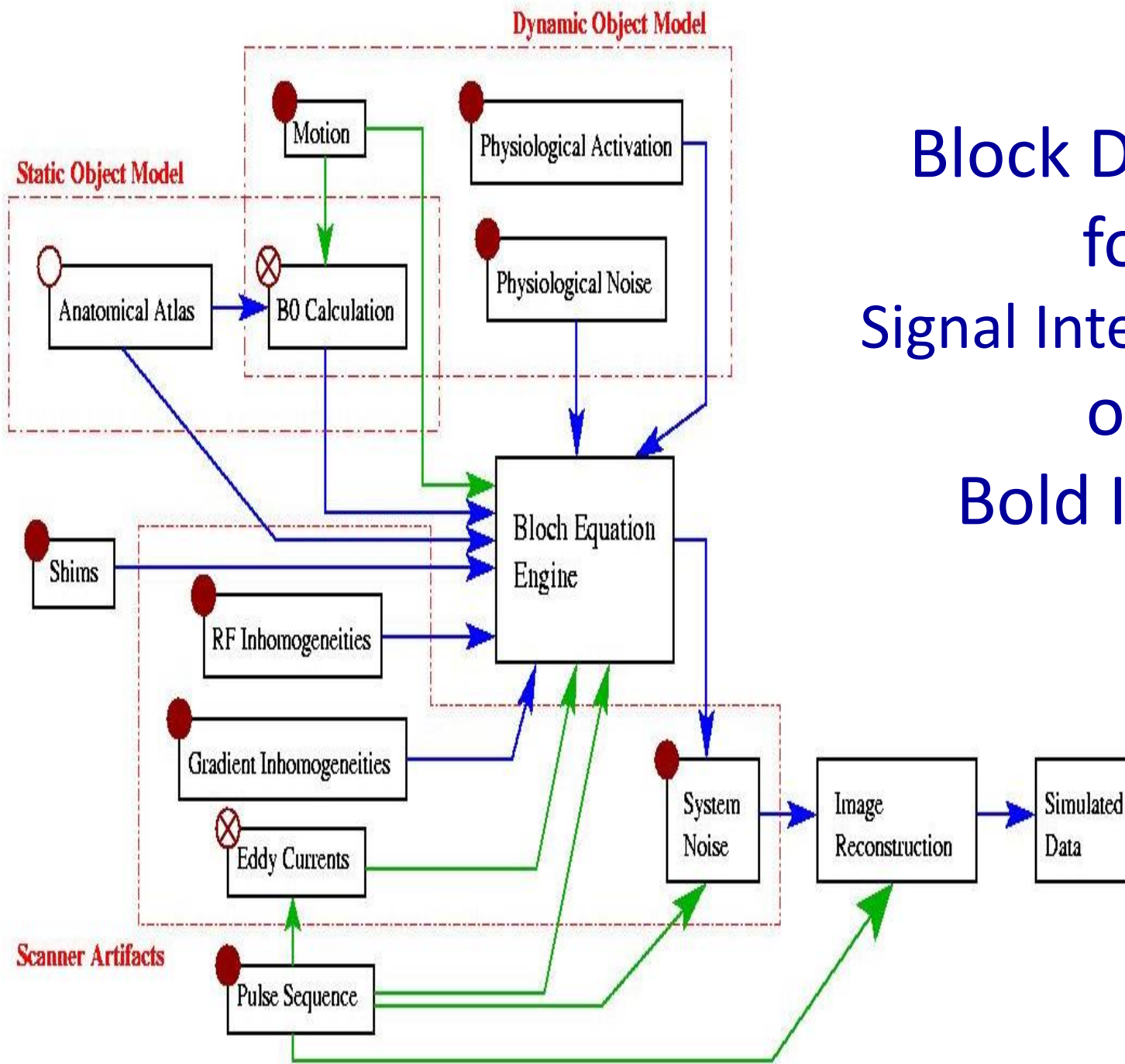
Off-resonance effects of water spins in EPI

generated by inhomogeneities in **main magnetic field** (poor shimming) and susceptibility effects, and induce geometric distortion

Parameters effecting EPI quality

(for fixed field of view)

Parameter	Echo spacing	Resolution	SNR	Geometric distortion
Increase gradient slew rate	Reduced	—	—	Reduced
Increase sampling bandwidth	Reduced	—	Reduced	Reduced
Increase the number of shots	Reduced	—	Increased	Reduced
Use of ramp sampling	Reduced	—	—	Reduced
Increase the read matrix	Increased	Increased	Reduced	Increased
Increase the phase encode matrix	—	Increased ¹	Reduced	—
Increase the field strength	—	—	Increased	Increased



Block Diagram for Signal Interferences on Bold Image